

Graph the image of the figure using the transformation given.

1) translation: 3 units left and 1 unit down

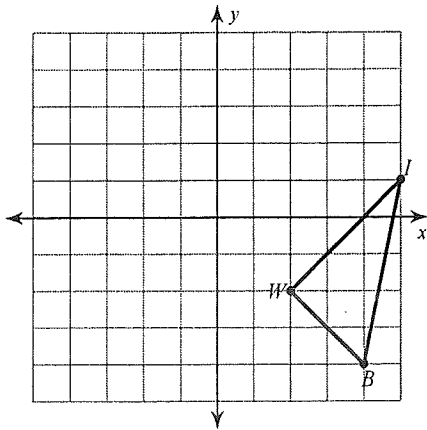

2) translation: 2 units left and 1 unit down

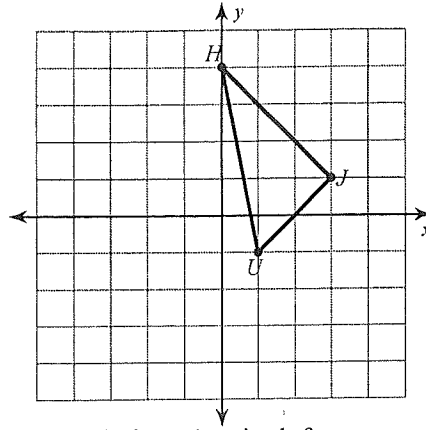

3) translation: 3 units left and 2 units up

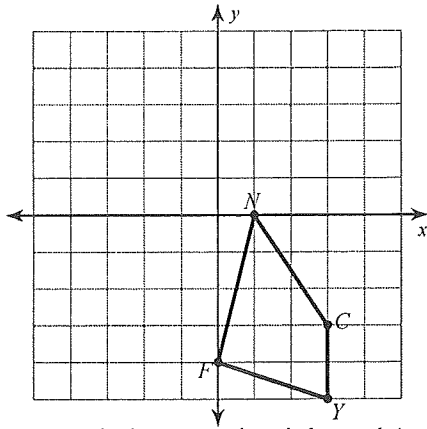

4) translation: 4 units left

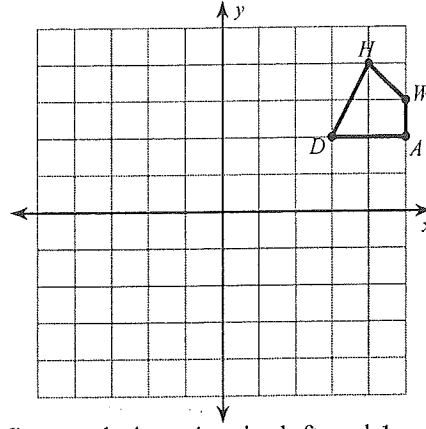

5) translation: 3 units right and 1 unit down

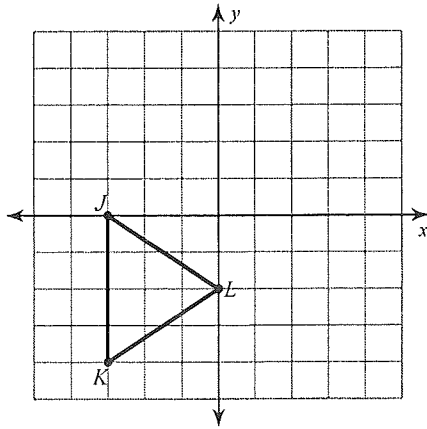

6) translation: 4 units left and 1 unit down

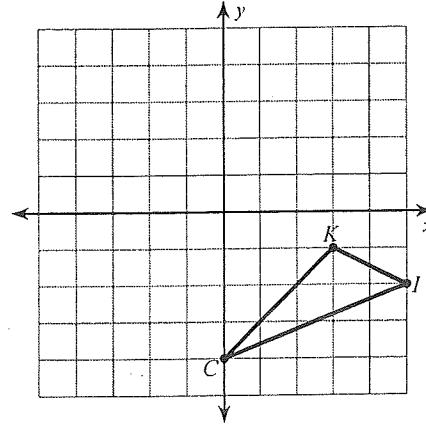

7) reflection across the y-axis

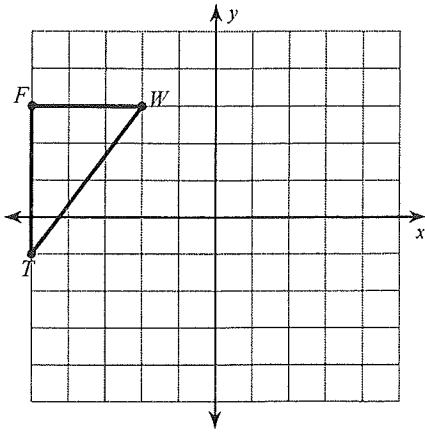

8) reflection across $y = 1$

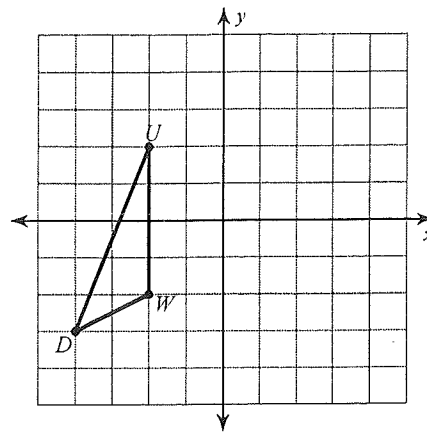

9) reflection across the y-axis

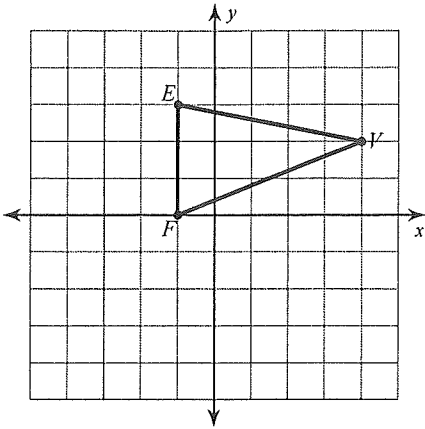

10) reflection across $y = 3$

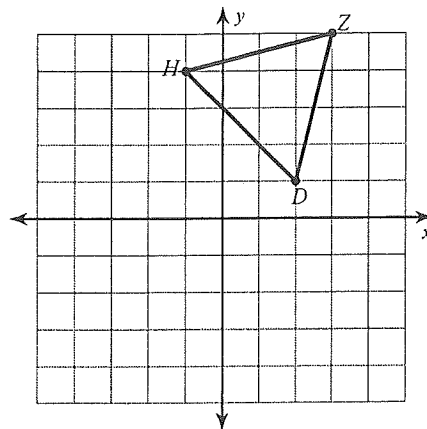

11) reflection across $y = 2$

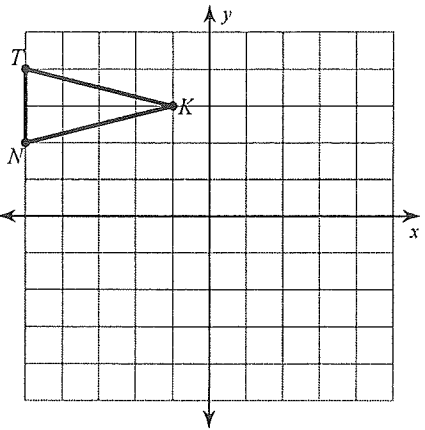

12) reflection across $x = 2$

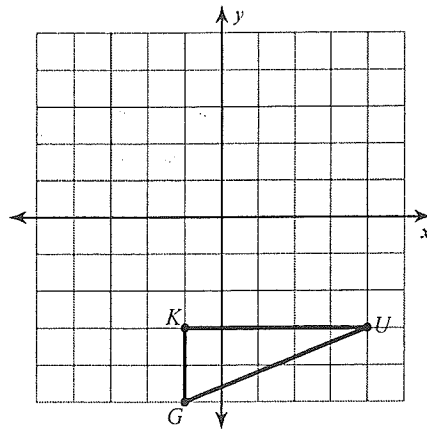

13) rotation 180° about the origin

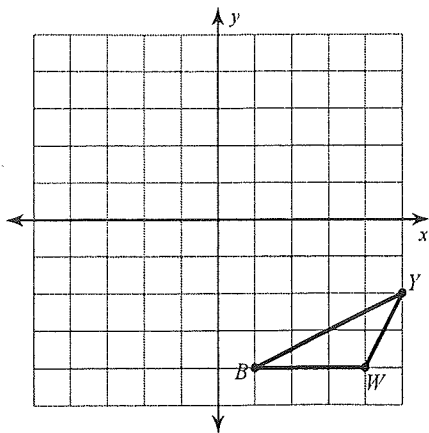

14) rotation 180° about the origin

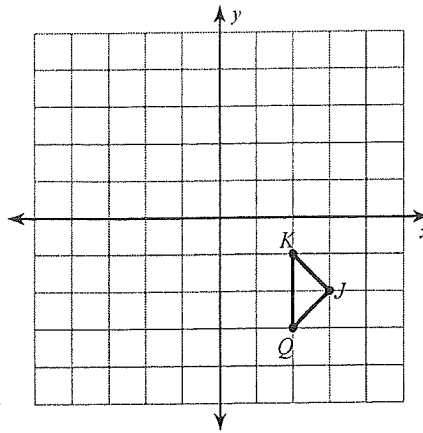

15) rotation 90° clockwise about the origin

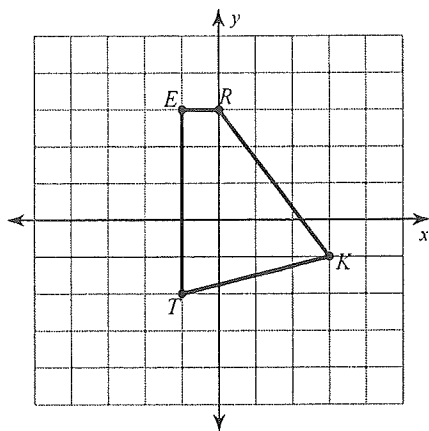

16) rotation 180° about the origin

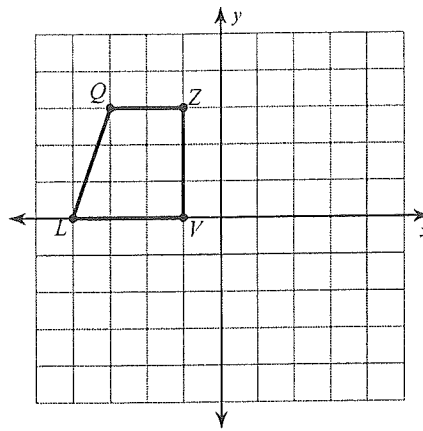

17) rotation 90° counterclockwise about the origin

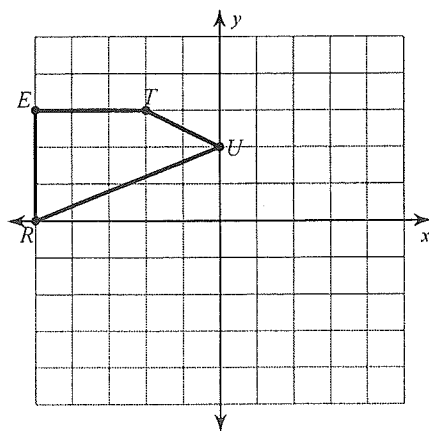

18) rotation 180° about the origin

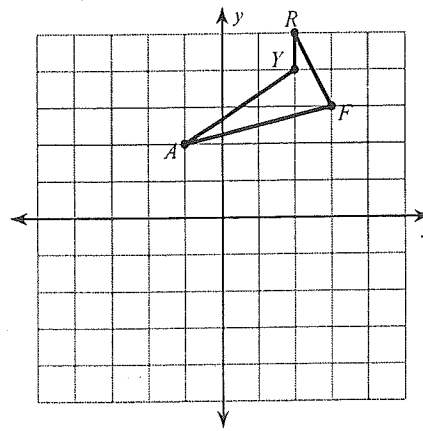

19) translation: 6 units right and 5 units down

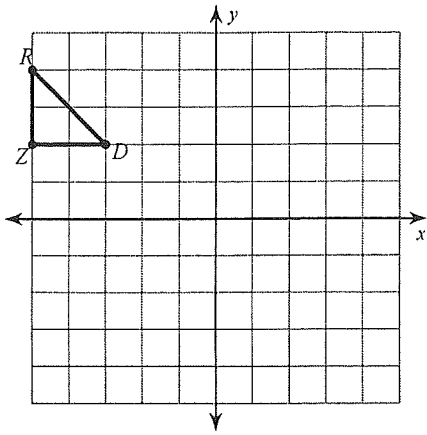

20) rotation 90° clockwise about the origin

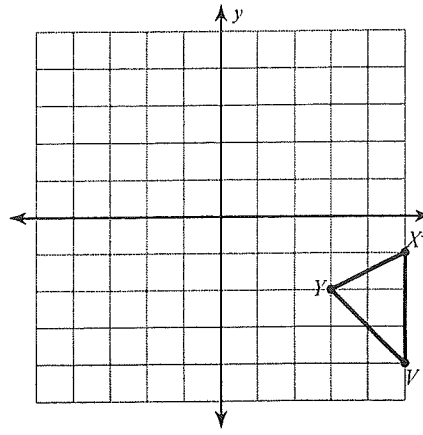

21) rotation 90° clockwise about the origin

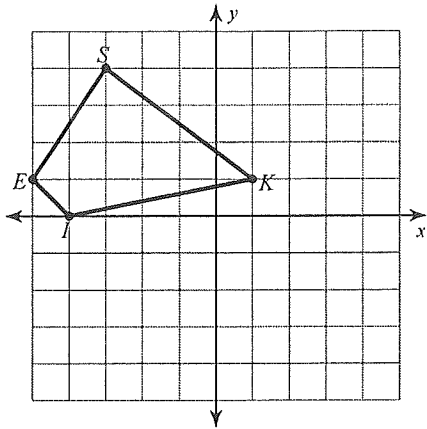

22) translation: 4 units right and 1 unit down

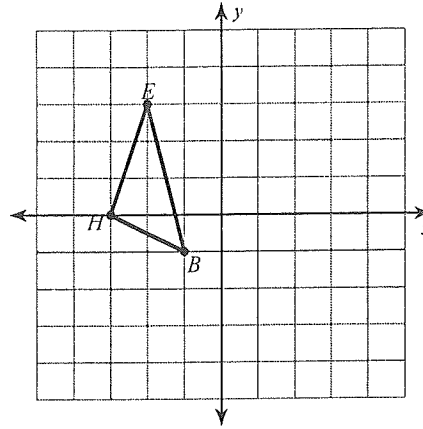

23) translation: 3 units left and 1 unit up

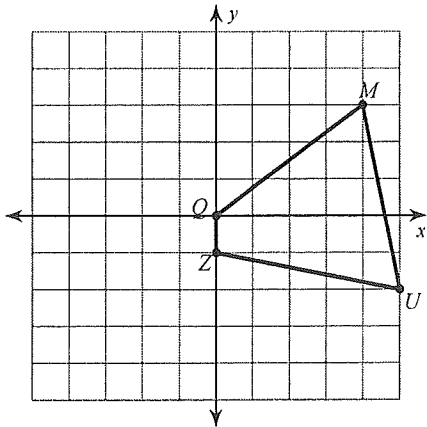

24) rotation 90° clockwise about the origin

